



*An Engineering-Driven Manufacturer
Providing Premier Service and
Innovative Metal Expansion Joints*



Our Company



Hose Master is North America's leading manufacturer of metal hose and expansion joints, with the industry's largest in-house fabricating footprint — over 350,000 square feet of manufacturing space in Cleveland, Ohio; Houston, Texas; and Atlanta, Georgia. Recognized for technical expertise and innovation, 10% of Hose Master's workforce is dedicated to research and development — providing continuous improvements to our wide range of products.

Hose Master is unique in our ability to implement a solution from initial concept to completion because we design and build our own state-of-the-art production equipment in our in-house machine shop.

Engineering & Manufacturing

At the heart of Hose Master's success is technical expertise. Proprietary equipment, designed and built in-house, makes the difference between ordinary products and superior, value-engineered products. Hose Master's expertise goes beyond manufacturing with a team of skilled engineers ready to assist you in designing an expansion joint for almost any application.



Quality Assurance

Delivering the highest quality products for the most demanding applications is a guiding principle at Hose Master. Designs conform to EJMA, ASME B31.1, and/or ASME B31.3. Customer specifications can be verified through Finite Element Analysis (FEA), or 3D CAD modeling. Expansion joint test options include pneumatic, hydrostatic, high-pressure gas, or liquid penetrant methods, as well as helium mass spectrometry and radiography.



Product & Failure Analysis

A key to permanently solving any tough expansion joint application is to accurately identify the root cause(s) of past failure modes of products removed from service. Hose Master's in-house product and failure analysis lab can identify various failure modes, whether a result of fatigue, corrosion, deformation, or from a host of other possible causes.

Hose Master is the only metal hose and expansion joint manufacturer in North America that offers in-house failure analyses and reverse engineering as a no-charge service to its distributor partners.



Service

With 80+ **ASME IX Certified** welders and a comprehensive material stocking program, Hose Master provides the exceptional service our industry demands. In addition to providing the best standard delivery lead-time, Hose Master offers our **After Hours Emergency Service** for hose and expansion joints, providing customers an expedited response for critical and time-sensitive situations that arise beyond normal business hours.



Expansion Joint Rebuild

Using customer-provided components from an expansion joint removed from service, Hose Master can replace bellows and often reuse pre-existing pipe and fittings. This offers a cost-effective option when dealing with very large diameter expansion joints and special designs.

Hose Master can also reverse-engineer the product for its specified application or evaluate the parts that are being replaced in our laboratory to determine the cause of failure.

Backed with this knowledge, Hose Master's team of engineers and ASME IX certified welders can design and make any necessary changes to the expansion joint to enhance its performance and extend its service life.



Product Design

Hose Master's staff of professional design engineers provides precise, timely responses to customer inquiries in conformance Expansion Joint Manufacturers Association (EJMA) standards. Designs for most common expansion joint configurations can often be quoted in minutes, or we can develop customized solutions for the most critical applications.

300 psi

Specifications for 800° F.
Pre-Engineered
Expansion Joint Products

Pipe Size (in)	No. Conv. (#)	Live Length (in)	Axial Movement (in)	Lateral (in)	Axial Spring Rate (lbs/in)	Lateral Spring Rate (lbs/in)	Angular Spring Rate (lbs-in/deg)	Bellows Weight (lbs)	300# Fixed RFSSO Flanges		Weld Nipples		300# Lap Joint Flanges	
									OAL (in)	Weight (lbs)	OAL (in)	Weight (lbs)	OAL (in)	Weight (lbs)
2	3	1.125	0.250	0.031	987	8070	15	0.19	3.88	14	4.13	1	6.13	19
	5	1.875	0.438	0.063	592	1743	9	0.34	4.63	14	4.88	1	6.88	19
	7	2.625	0.563	0.188	676	1014	10	0.49	5.38	14	5.63	1	7.63	19
	9	3.500	0.625	0.250	818	691	12	0.66	6.25	15	6.50	2	8.50	19
	11	4.250	0.690	0.313	930	535	14	0.87	7.00	15	7.25	2	9.25	19
	13	5.500	0.813	0.563	1314	455	20	1.49	8.25	15	8.50	2	10.50	20
	15	6.500	0.875	0.688	1627	403	25	1.86	9.25	16	9.50	3	11.50	20
					13638		31	0.43	4.38	20	4.25	2	6.25	27
					3116		18	0.55	5.13	21	5.00	2	7.00	27
					1569		21	0.78	6.13	21	6.00	2	8.00	28
					963		21	1.08	7.00	21	6.88	3	8.88	28
					851		31	1.84	8.13	22	8.00	3	10.00	29
									9.25	22	9.13	4	11.13	29
									10.38	23	10.25	4	12.25	30
									4.88	27	4.63	3	6.38	36
									5.88	27	5.63	3	7.38	36
									6.88	27	6.63	3	8.38	37
									7.88	28	7.63	4	9.38	37
									9.01	29	8.75	5	10.50	38
									5.38	45	4.63	4	6.97	59
									6.38	45	5.63	4	7.28	59



HOSE MASTER

1233 East 22nd Street
Euclid, OH 44117
(800) 221-2319
Fax (216) 481-7587
www.hosemaster.com

DESIGN# XMPL-DSGN-PK1

Physical Dimension per Drawing XMPL-DSGN-PK1
Bellows Performance Variables per Bellows Design

OPTIONS

Testing
Low Pressure Test: 10 psi for 5 min.
Hydraulic Test: 225 psi for 5 min.
Radiograph exam welds per ASME B
Component(s): Bellows
Liquid Penetrant Inspection attached
Component(s): Pressure-carrying

Special Identification / Markings
Standard Tag Requirements
Welded Hose Master ID Tag
Location: Manufacturer's Choice

Certifications
Certificate of Test

Finishing
Remove all loose debris and foreign
Buff all welds to remove oxidation.
Oil carbon steel fittings machined sur
Paint carbon steel components: Lo-T

Packaging
Ship assembly with welded shipping
Packaged as per Manufacturer's Sta

NOTES:
FOR EXAMPLE ONLY

Bellows Design Analysis
Expansion Joint XMPL-DSGN-PK1
Date: 10/10/2012

8" NPS X 12" OAL SINGLE EXPANSION JOINT

Design Parameters

Design Pressure	150	psi
Design Temperature	800	deg F
Design Cycle Life	3000	Cycles

Bellows design for "flow and greater will hold Full Vacuum"

Movements Set 1 (Calculated as Concurrent/Combined)

Compression	-1	in	Extension	0	in
Lateral 1	-0.25	in	Lateral 2	0	in
Angular 1	0	deg	Angular 2	0	deg

Bellows Performance Data

Actual Cycle Life	
Cycle Life Per EJMA	3167 Cycles

Bellows Spring Forces

Axial Spring Rates	1025	lbs/in
Lateral Spring Rates	2714	lbs/in
Angular Spring Rates	194	lb-in/deg
Torsional Spring Rates	2.62e+05	in-lb/in

Pressure Thrust

Area	
Effective Bellows Area	67.914

Individual Stresses and Pressure

Stress @ Design Pressure (psi)	Allowable Stress (psi)
81	9000
52	10000
92	9000
1314	10000

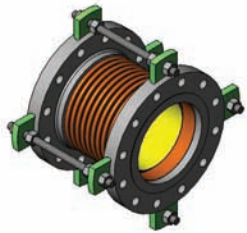
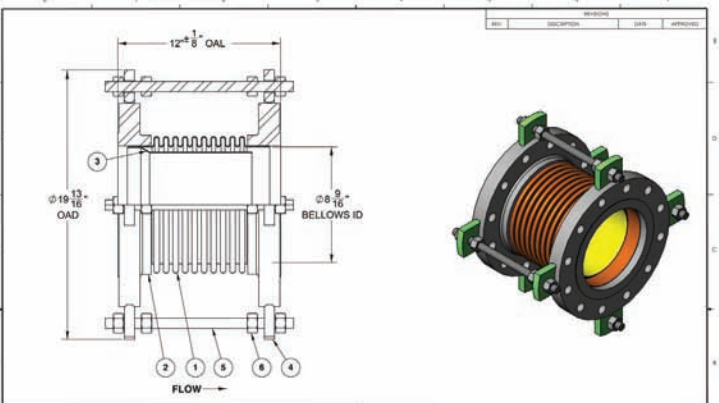
COMPONENTS LIST

ITEM #	QTY.	DESCRIPTION	MATERIAL
1	1	Bellows, 3-Ply, Performance Per Design Analysis XMPL-DSGN-PK1	A240-321
2	2	Flange, Slip-on, Raised Face, Class 300, 8.00"	ASTM A105-CST
3	1	Line, 7.884" ID, 0.60" Thick, 9.188" Long	A240-304
4	8	Lug, Hardware, for 8" Expansion Joint, 0.875" Hole	ASTM A36-CST
5	4	Threaded Rod, 10 Threads/in., 0.75"	A193-CST
6	16	Heavy Hex Nut, 10 Threads/inch, 0.75"	CST

HOSE MASTER
1233 East 22nd Street • Euclid, Ohio 44117
(800) 221-2319 Fax (216) 481-7587 www.hosemaster.com
Cleveland • Houston • Atlanta

ISO 9001
Registered Quality System

HOSE MASTER
1233 East 22nd Street • Euclid, Ohio 44117
(800) 221-2319 Fax (216) 481-7587 www.hosemaster.com
Cleveland • Houston • Atlanta

8" NPS X 12" OAL SINGLE EXPANSION JOINT

XMPL-DSGN-PK1

CUSTOMER COPY



Pre-Engineered Expansion Joints vs. Custom Designed Solutions

Pre-Engineered Expansion Joint Products

Pre-engineered expansion joint products incorporate designs for common industrial applications to provide more immediate order availability. Hose Master's pre-engineered expansion joint data charts are presented as a resource to assist sales, engineering, MRO, and purchasing professionals by providing baseline data during discussions in the initial design phase. Please refer to pages 9-16 for product designs and specifications.

Custom Designed Expansion Joints

A founding principle of Hose Master is to provide solutions through intelligent, customer-driven design. As no two opportunities are identical, off-the-shelf solutions are often impractical for addressing all critical variables of the most demanding applications. Custom designed expansion joint products range from 2"-120" nominal diameter, and are available with an array of alloys and end fittings to suit any expansion joint application. Because of their many options, custom designed expansion joints are engineered to suit specific needs. Please refer to pages 5-6 for product offerings and inside back cover for our Expansion Joint Specification Inquiry Sheet.

Design Assistance

Determining the right expansion joint for mission critical applications can be intimidating. Contact the experts at Hose Master for assistance in designing the expansion joint best suited for your specific application, and let our staff of engineers take the worry out of the selection process.

Accompanying every product quotation is a design package complete with full performance specifications and detailed engineering drawings.

Cover Sheet - Lists standard manufacturing procedures and provides summary of options selected in accordance with the expansion joint design, including:

- Test and inspection criteria
- Tagging and identification specifications
- Accessories (*such as lifting lugs and insulation*)
- Certifications (*such as agency approval, material origin, conformance, and fabrication*)
- Finishing details
- Packaging and shipping accessories

Design Stress Analysis - Documents the bellows design specifications and corresponding forces acting upon the piping system in which the expansion joint will be installed.

- Expansion Joint Design Parameters (*Pressure, Temperature, Design Cycle Life, Movements*)
- Bellows Performance Data (*Cycle Life, Operating Pressure*)
- Bellows Spring Forces (*Spring Rates and Resultant Force*)
- Pressure Thrust (*Area, Pressure, and Resultant Force*)
- Individual stresses for the given bellows convolution profile

Detailed Drawings and Components List

- Drawings completed to scale, with maximum envelope dimensions
- Component list showing all materials used in manufacturing



Expansion Joint Range

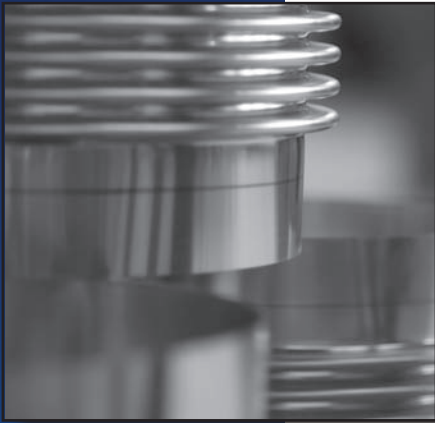

Size Range

- From 2" - 120" nominal diameter (tube sizes also available), single and multi-ply

Alloys

- Stainless steels - T304, T304L, T309, T310, T321, T316, T316L
- Nickel - 400, 600, 625, 625LCF, 800, 800H, Nickel 200, C276
- Other alloys available upon request

Pressure

- From full vacuum to 3000 psi

Temperature

- Range from -450° F to 2000° F

Expansion Joint Types

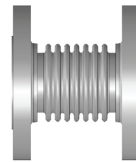

US
Unrestrained
Single

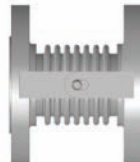

SHS
Slotted Hinged
Single

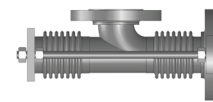

PBS
Pressure
Balanced,
Elbow, Single



LS
Limit
Single

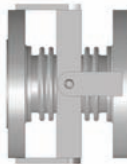

GS
Gimbaled
Single

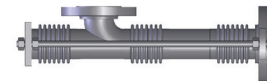

PBU
Pressure
Balanced,
Elbow,
Universal



TS
Tied
Single

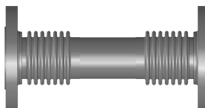

UU
Unrestrained
Universal

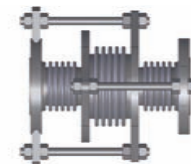

PBI
Pressure
Balanced
In-Line

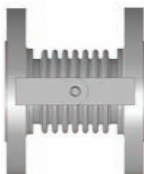

HS
Hinged
Single

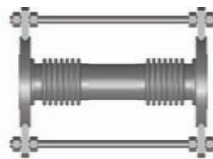

TU
Tied
Universal

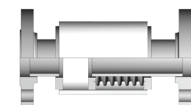

EPS
Externally
Pressurized
Single

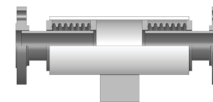

EPD
Externally
Pressurized
Dual

Internal Liners

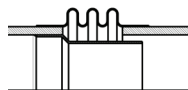

SW - Single Welded
These liners are the most common type of internal liner.

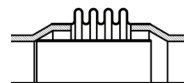

FW - Flush Welded
Also known as "full-flow liners", these offer no protrusion into flow stream and cause minimal pressure drop.

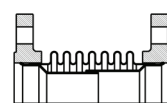

TW - Telescoping Welded
These liners are used when large axial movement is a concern.

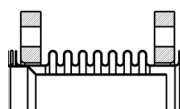

SD - Single Drop-in
These liners can be removed for cleaning.



TD - Telescoping Drop-in
These liners are used for large axial movement and can be removed and cleaned.

Comparison of Ratings, Features & Options

Expansion Joint Types	Relative Movement Capacity			Relative Spring Forces			Pressure Thrust on a Piping System	Available Features		
	Axial	Angular	Lateral	Axial	Angular	Lateral		Internal Flow Liner Types	External Cover	Redundant Ply Design
US Unrestrained Single	↔	↔	↓	↔	↔	↑	Yes	SW, TW, FW, SD, TD	Yes	Yes
LS Limit Single	↔	↔	↓	↔	↔	↑	Yes	SW, TW, FW, SD, TD	Yes	Yes
TS Tied Single	-	-	↓	-	-	↑	No	SW, TW, FW, SD, TD	Yes	Yes
HS Hinged Single	-	↔	-	-	↔	-	No	SW, TW, FW, SD, TD	Yes	Yes
SHS Slotted Hinge Single	↔	↔	-	↔	↔	-	Yes	SW, TW, FW, SD, TD	Yes	Yes
GS Gimbaled Single	-	↔	-	-	↔	-	No	SW, TW, FW, SD, TD	Yes	Yes
UU Unrestrained Universal	↔	↔	↑	↔	↔	↓	Yes	SW, TW, FW, SD, TD	Yes	Yes
TU Tied Universal	-	-	↑	-	-	↓	No	SW, TW, FW, SD, TD	Yes	Yes
PBS Pressure-Balanced, Elbow, Single	↔	-	↔	↔	↔	↑	No	SW, TW, FW, SD, TD	Yes	Yes
PBU Pressure-Balanced, Elbow, Universal	↔	-	↑	↔	↔	↓	No	SW, TW, FW, SD, TD	Yes	Yes
PBI Pressure-Balanced In-Line	↔	-	-	↔	-	-	No	SW, TW, FW, SD, TD	Yes	Yes
EPS Externally-Pressurized Single	↑	-	-	↔	-	-	Yes	FW	Incl	Yes
EPD Externally-Pressurized Dual	↑	-	-	↔	-	-	Yes	FW	Incl	Yes

Legend: ↑ Higher ↔ Moderate ↓ Lower - Non Applicable

Options

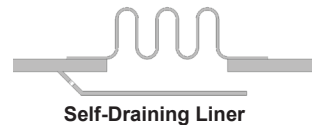
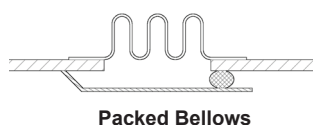
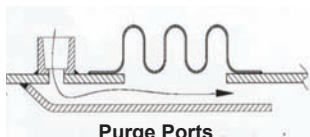

Pressure Thrust



Expansion joints must be very flexible in order to absorb axial movement. This inherent flexibility prevents the expansion joint from restraining longitudinal pressure loads and results in a force being exerted on the piping system known as **pressure thrust**.

Pressure thrust is calculated by multiplying the effective area of the bellows by the system pressure. With larger diameter bellows and/or higher pressure applications, the pressure thrust exerted by the bellows can be quite significant — hundreds of thousands of pounds.

If the ends of an expansion joint were capped and it was then pressurized, the bellows would extend freely until it formed a tube (its original shape). This type of unrestrained extension would destroy the expansion joint. To maintain the structural integrity of the piping system, the pressure thrust must be balanced or restrained. Often, pipe anchors can be designed to withstand the pressure thrust. If no axial movement is required, tie rods can be installed on the expansion joint to contain the pressure thrust. In some situations, where axial movement is required and pipe anchors are not practical, a pressure-balanced expansion joint is the solution.

Pressure-balanced expansion joints completely balance the pressure thrust within the expansion joint assembly through the addition of an opposing (or balancing) bellows. This greatly simplifies piping anchor and support requirements. Turbines and other reciprocating equipment frequently require the implementation of pressure-balanced expansion joints to eliminate nozzle loads due to pressure thrust.

Most common pressure-balanced systems require a change in piping direction. These applications use our Pressure-Balanced Single (PBS) or Pressure-Balanced Universal (PBU) styles. For those applications where there is no change in piping direction our Pressure-Balanced In-Line (PBI) style is the preferred selection. Please refer to page 5 for details.

Expansion Joints vs. Metal Hose



Braided metal hose assemblies and expansion joints share many similar attributes, but it is their differences in construction that determine which is best for a specific application.

Braided metal hose assemblies are constructed from flexible, corrugated hose typically formed using a single layer of strip. The number of corrugations per foot dictates the flexibility of the hose, while the outer braid layer provides its pressure bearing capability. Braided metal hoses are designed to accommodate one plane of movement: either lateral (side to side), or angular (one end moving, or bending, relative to the other). Axial movement (compression or extension) is to be avoided, as it can cause the braid to loosen from the hose, thus reducing its pressure bearing capability and leaving the hose susceptible to squirm.

Because **expansion joints** are designed to accommodate pressure and movements without the need for braid, they are capable of handling all three planes of movement: lateral, angular, and axial. Expansion joint movement and pressure bearing capabilities are determined by the number of convolutions, as well as material thickness, number of plies, and wall height specified by the product's individual design.

Multi-ply expansion joints are ideally suited for applications where vibration may be present. Additionally, multi-ply designs feature lower spring rates which reduces stress on piping components, and increases cycle life for a given installation.

Pre-Engineered Expansion Joint Types

Though Hose Master manufactures many customized and intricate expansion joints for a variety of specialized applications, there are four basic designs that are most commonly used. Each is available in 15, 50, 150, and 300 psi design pressures and is manufactured from T321 or T316 stainless steel. Available sizes range from 2" - 30" nominal diameter.

Basic Bellows

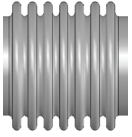

A bellows can be supplied without end fittings for field installation. The skirt (straight portion at each end of the bellows) can be sized to fit a flange or pipe. Please specify skirt length and attachment type when ordering.

Unrestrained Single

An unrestrained single expansion joint is best used when piping systems are equipped with proper guides and anchors to absorb axial, angular, and a small amount of lateral movement.

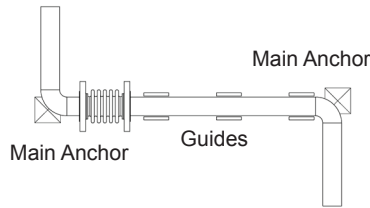
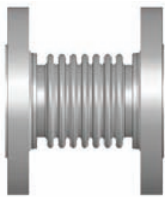

Example of an unrestrained single expansion joint used in a proper piping system to absorb axial pipeline expansion.

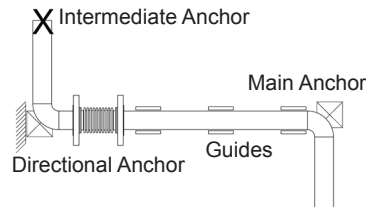

Example of an unrestrained single expansion joint used in a proper piping system to absorb lateral deflection, as well as axial compression.

Limit Single

A limit single expansion joint is best used when main anchors and guides are in the pipeline. It allows for some axial movement as well as lateral movement; however, the hardware protects the expansion joint from exceeding its design movements.

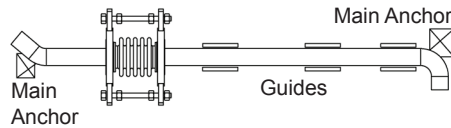
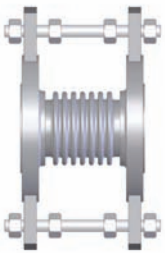

Example of a Limit Single expansion joint used in piping systems with main anchors. The limit rods prevent damage to the expansion joint and piping system by absorbing full pressure thrust.

Tied Single

A tied single expansion joint is best used in piping systems without a main anchor. It allows for lateral movement only while also restraining pressure thrust.

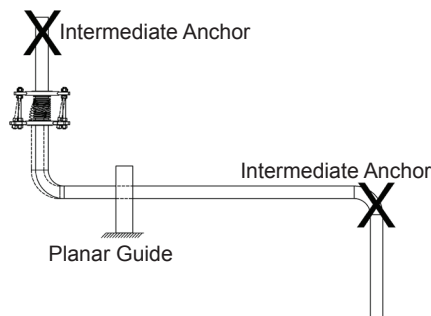
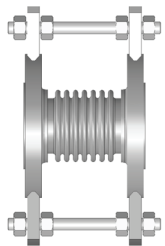

Example of a Tied Single expansion joint where the expansion joint is installed 90° to the thermal growth of the piping. Because of the rods, the expansion joint is able to absorb lateral movement only.

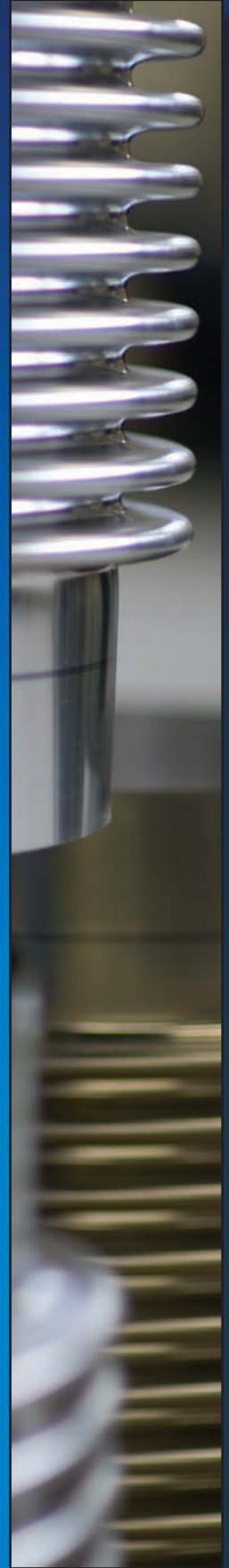

15 PSI

Specifications for 800° F. Exhaust Pre-Engineered Expansion Joint Products

Pipe Size (in.)	No. of Conv. (#)	Live Length (in.)	Axial Movement (in.)	Lateral Movement (in.)	Axial Spring Rate (lbs/in.)	Lateral Spring Rate (lbs/in.)	Angular Spring Rate (lbs-in/deg)	Bellows Weight (lbs)	150# Fixed or Floating Light Weight Plate Flanges		Weld Nipples	
									OAL (in.)	Weight (lbs)	OAL (in.)	Weight (lbs)
2	3	1.125	0.188	0.031	1033	8414	16	0.30	2.50	8	4.13	1
	5	1.875	0.375	0.090	620	1817	9	0.30	3.25	9	4.88	1
	7	2.500	0.500	0.125	419	692	6	0.40	3.88	9	5.50	1
	9	3.250	0.688	0.250	330	322	5	0.50	4.63	9	6.25	1
	11	4.000	0.813	0.438	272	175	4	0.50	5.38	9	7.00	1
	13	4.750	1.000	0.563	231	106	3	0.60	6.13	9	7.75	2
	15	5.500	1.125	0.813	201	69	3	0.70	6.88	9	8.50	2
2.5	3	1.250	0.313	0.031	812	8525	19	0.40	2.63	11	4.25	2
	5	2.000	0.500	0.063	467	1914	11	0.50	3.38	11	5.00	2
	7	2.875	0.688	0.188	342	680	8	0.60	4.25	11	5.88	2
	9	3.625	0.938	0.313	261	326	6	0.70	5.00	11	6.63	2
	11	4.500	1.125	0.500	217	176	5	0.80	5.88	12	7.50	2
	13	5.250	1.313	0.688	181	108	4	0.90	6.63	12	8.25	2
	15	6.000	1.563	0.938	156	71	4	1.00	7.38	12	9.00	2
3	3	1.375	0.438	0.031	435	5352	15	0.50	2.75	12	4.63	3
	5	2.250	0.750	0.125	256	1176	9	0.60	3.63	12	5.50	3
	7	3.125	1.125	0.250	181	432	6	0.80	4.50	13	6.38	3
	9	4.000	1.438	0.438	140	204	5	0.90	5.38	13	7.25	3
	11	4.875	1.750	0.688	115	112	4	1.10	6.25	13	8.13	3
	13	5.750	2.063	1.000	97	68	3	1.20	7.13	13	9.00	3
	15	6.625	2.438	1.313	84	44	3	1.40	8.00	13	9.88	3
4	3	1.500	0.500	0.031	537	8534	28	0.60	2.88	17	4.63	3
	5	2.375	0.813	0.125	307	1944	16	0.80	3.75	17	5.50	4
	7	3.375	1.188	0.250	222	697	12	1.00	4.75	17	6.50	4
	9	4.375	1.500	0.438	174	325	9	1.20	5.75	17	7.50	4
	11	5.375	1.875	0.688	143	177	7	1.40	6.75	18	8.50	4
	13	6.250	2.188	0.938	119	109	6	1.60	7.63	18	9.38	4
	15	7.250	2.563	1.250	104	71	5	1.80	8.63	18	10.38	5
5	3	1.625	0.688	0.063	350	7560	29	0.90	2.75	15	6.38	7
	5	2.750	1.188	0.125	213	1606	18	1.20	3.88	16	7.50	7
	7	3.875	1.688	0.313	153	581	13	1.50	5.00	16	8.63	7
	9	5.000	2.188	0.563	120	272	10	1.80	6.13	16	9.75	8
	11	6.125	2.688	0.875	98	149	8	2.10	7.25	16	10.88	8
	13	7.375	2.750	1.063	136	142	11	2.80	8.50	17	12.13	9
	15	8.500	3.188	1.438	118	93	10	3.20	9.63	18	13.25	9
6	3	1.625	0.750	0.031	396	11730	45	1.10	2.75	18	6.25	8
	5	2.750	1.250	0.125	239	2473	27	1.50	3.88	18	7.38	8
	7	3.875	1.750	0.313	171	892	20	1.90	5.00	19	8.50	9
	9	5.000	2.250	0.500	133	418	15	2.20	6.13	19	9.63	9
	11	6.125	2.750	0.750	109	228	12	2.60	7.25	19	10.75	9
	13	7.250	3.000	0.938	92	138	11	2.90	8.38	20	11.88	10
	15	8.500	3.188	1.250	134	145	15	3.90	9.63	21	13.13	11
8	3	1.875	0.875	0.031	361	13347	68	1.70	3.00	25	6.50	13
	5	3.250	1.500	0.125	221	2717	42	2.30	4.38	25	7.88	13
	7	4.500	2.063	0.313	157	1006	30	2.80	5.63	26	9.13	14
	9	5.750	2.688	0.500	122	478	23	3.30	6.88	26	10.38	14
	11	7.000	3.250	0.813	99	263	19	3.90	8.13	27	11.63	15
	13	8.500	3.500	1.063	141	253	27	5.30	9.63	28	13.13	16
	15	9.750	4.063	1.250	122	166	23	5.90	10.88	29	14.38	17

CHARTS PRESENTED AS A RESOURCE TO PROVIDE BASELINE DATA FOR DISCUSSION DURING THE INITIAL DESIGN PHASE. For practical purposes, a multitude of expansion joint bellows iterations may meet required operating parameters. Contact Hose Master for assistance in design or selection of the expansion joint best suited for your specific application. • Angular movement for all designs is 5 degrees. • EJMA cycle life 10,000 non-concurrent.

Pipe Size (in.)	No. of Conv. (#)	Live Length (in.)	Axial Movement (in.)	Lateral Movement (in.)	Axial Spring Rate (lbs/in.)	Lateral Spring Rate (lbs/in.)	Angular Spring Rate (lbs-in/deg)	Bellows Weight (lbs)	150# Fixed or Floating Light Weight Plate Flanges		Weld Nipples	
									OAL (in.)	Weight (lbs)	OAL (in.)	Weight (lbs)
10	3	2.125	1.000	0.031	286	12676	83	2.30	3.25	32	7.25	20
	5	3.625	1.688	0.125	174	2643	51	3.10	4.75	32	8.75	20
	7	5.000	2.313	0.313	123	985	36	3.90	6.13	33	10.13	21
	9	6.500	3.063	0.563	96	456	28	4.60	7.63	34	11.63	22
	11	8.000	3.688	0.813	130	408	38	6.50	9.13	36	13.13	24
	13	9.625	4.063	1.125	171	369	50	8.60	10.75	38	14.75	26
	15	11.000	4.688	1.438	148	244	43	9.70	12.13	39	16.13	27
12	3	2.375	1.125	0.063	261	12895	106	2.90	3.50	46	6.25	20
	5	4.000	1.875	0.125	158	2744	64	3.90	5.13	47	7.88	21
	7	5.625	2.625	0.313	113	995	46	4.90	6.75	48	9.50	22
	9	7.125	3.375	0.375	87	478	35	5.90	8.25	49	11.00	23
	11	8.875	4.125	0.875	118	418	48	8.30	10.00	51	12.75	26
	13	10.625	4.875	1.250	154	381	63	11.10	11.75	54	14.50	28
	15	12.375	5.063	1.500	189	345	77	14.30	13.50	58	16.25	32
14	3	2.375	1.125	0.031	279	16421	135	3.20	3.50	56	8.38	30
	5	4.000	1.875	0.125	168	3489	81	4.30	5.13	57	10.00	32
	7	5.625	2.625	0.313	120	1263	58	5.40	6.75	58	11.63	33
	9	7.125	3.375	0.500	93	608	45	6.50	8.25	59	13.13	34
	11	8.875	4.125	0.813	127	534	61	9.10	10.00	62	14.88	36
	13	10.625	4.875	1.125	166	487	80	12.20	11.75	65	16.63	39
	15	12.375	5.000	1.375	204	443	99	15.80	13.50	69	18.38	43
16	3	2.375	1.063	0.031	512	38789	319	4.30	3.50	66	8.38	36
	5	4.000	1.875	0.125	308	8222	192	5.90	5.13	68	10.00	37
	7	5.625	2.625	0.250	220	2973	137	7.40	6.75	69	11.63	39
	9	7.250	3.375	0.438	171	1393	107	8.90	8.38	71	13.25	40
	11	8.875	4.125	0.688	140	761	87	10.40	10.00	72	14.88	42
	13	10.625	4.750	1.000	184	697	115	13.90	11.75	76	16.63	45
18	3	2.625	1.188	0.031	407	31963	321	5.20	4.88	136	8.63	41
	5	4.375	2.063	0.125	244	6904	193	7.10	6.63	138	10.38	42
	7	6.250	2.938	0.313	175	2429	138	9.10	8.50	139	12.25	44
	9	8.000	3.750	0.500	136	1152	107	11.00	10.25	141	14.00	46
	11	9.875	4.063	0.500	172	955	136	15.00	12.13	145	15.88	50
	13	11.625	4.380	0.750	146	583	115	17.30	13.88	148	17.63	53
	20	3	2.625	1.188	0.031	442	42391	426	5.80	5.00	168	8.63
5		4.375	2.063	0.125	265	9156	256	7.90	6.75	170	10.38	47
7		6.250	2.938	0.250	190	3217	183	10.10	8.63	172	12.25	49
9		8.000	3.750	0.438	148	1526	142	12.20	10.38	175	14.00	52
11		9.875	4.500	0.688	188	1273	181	16.70	12.25	179	15.88	56
13		11.625	5.000	1.000	159	777	153	19.20	14.00	182	17.63	59
24	3	2.625	1.188	0.031	513	69814	702	7.00	5.25	231	8.63	54
	5	4.375	2.063	0.063	308	15080	421	9.50	7.00	234	10.38	57
	7	6.250	2.938	0.188	220	5286	301	12.10	8.88	236	12.25	59
	9	8.000	3.750	0.313	171	2509	234	14.60	10.63	239	14.00	62
	11	9.750	4.500	0.563	140	1382	192	17.20	12.38	241	15.75	65
	13	11.625	5.000	0.813	185	1284	253	23.00	14.25	247	17.63	70
28	3	3.125	1.438	0.031	399	52119	742	10.00	5.88	306	9.13	66
	5	5.250	2.500	0.125	240	11097	446	13.50	8.00	310	11.25	70
	7	7.250	3.438	0.250	171	4146	318	17.00	10.00	313	13.25	73
	9	9.500	4.438	0.438	207	2919	384	23.90	12.25	320	15.50	80
	11	11.500	5.000	0.688	169	1629	314	27.90	14.25	324	17.50	84
30	3	3.125	1.438	0.031	422	62896	896	10.80	5.88	349	9.13	71
	5	5.250	2.500	0.125	253	13381	538	14.50	8.00	352	11.25	74
	7	7.250	3.438	0.250	181	5005	384	18.20	10.00	356	13.25	78
	9	9.375	4.438	0.438	141	2329	299	21.90	12.13	360	15.38	82
	11	11.500	5.438	0.625	179	1970	380	29.90	14.25	368	17.50	90

50 PSI

Specifications for 800° F. Pre-Engineered Expansion Joint Products

Pipe Size (in.)	No. of Conv. (#)	Live Length (in.)	Axial Movement (in.)	Lateral Movement (in.)	Axial Spring Rate (lbs/in.)	Lateral Spring Rate (lbs/in.)	Angular Spring Rate (lbs-in/deg)	Bellows Weight (lbs)	150# Fixed or Floating Plate Flanges		Weld Nipples	
									OAL (in.)	Weight (lbs)	OAL (in.)	Weight (lbs)
2	3	1.000	0.219	0.031	719	7394	11	0.16	2.38	8	4.00	1
	5	1.750	0.375	0.063	440	1476	7	0.20	3.13	8	4.75	1
	7	2.500	0.563	0.188	317	522	5	0.24	3.88	8	5.50	1
	9	3.125	0.750	0.250	243	256	4	0.28	4.50	8	6.13	1
	11	3.875	0.938	0.438	195	134	3	0.32	5.25	9	6.88	1
	13	4.625	1.063	0.625	206	101	3	0.44	6.00	9	7.63	1
	15	5.375	1.063	0.688	260	94	4	0.56	6.75	9	8.38	1
2.5	3	1.125	0.313	0.031	567	7349	14	0.22	2.50	11	4.13	2
	5	2.000	0.563	0.063	349	1430	8	0.28	3.38	11	5.00	2
	7	2.750	0.750	0.188	247	536	6	0.34	4.13	11	5.75	2
	9	3.500	1.000	0.313	191	256	5	0.40	4.88	11	6.50	2
	11	4.250	1.125	0.438	217	199	5	0.55	5.63	11	7.25	2
	13	5.125	1.188	0.563	265	167	6	0.71	6.50	12	8.13	2
	15	6.000	1.375	0.813	228	105	6	0.79	7.38	12	9.00	2
3	3	1.250	0.500	0.031	312	4648	11	0.28	2.63	12	4.50	2
	5	2.125	0.813	0.125	189	971	6	0.37	3.50	12	5.38	2
	7	3.000	1.188	0.250	135	349	5	0.46	4.38	12	6.25	3
	9	3.875	1.313	0.438	162	251	5	0.65	5.25	13	7.13	3
	11	4.750	1.438	0.563	193	199	7	0.86	6.13	13	8.00	3
	13	5.750	1.563	0.750	230	162	8	1.10	7.13	13	9.00	3
	15	6.625	1.625	0.875	255	136	9	1.39	8.00	13	9.88	3
4	3	1.375	0.500	0.031	390	7378	20	0.36	2.75	16	4.50	3
	5	2.375	0.875	0.125	237	1503	12	0.48	3.75	16	5.50	3
	7	3.250	1.188	0.250	168	568	9	0.60	4.63	17	6.38	3
	9	4.250	1.375	0.375	201	399	10	0.83	5.63	17	7.38	4
	11	5.250	1.500	0.500	240	312	13	1.11	6.63	17	8.38	4
	13	6.250	1.625	0.688	274	251	14	1.44	7.63	17	9.38	4
	15	7.250	1.750	0.813	297	204	16	1.83	8.63	18	10.38	5
5	3	1.625	0.750	0.063	273	5890	23	0.51	3.25	21	6.38	6
	5	2.750	1.250	0.188	162	1221	13	0.70	4.38	21	7.50	6
	7	3.875	1.563	0.313	177	673	15	1.02	5.50	21	8.63	7
	9	5.000	1.563	0.438	265	608	22	1.61	6.63	22	9.75	7
	11	6.125	1.813	0.563	289	442	24	2.10	7.75	22	10.88	8
	13	7.375	1.813	0.688	423	458	36	3.07	9.00	23	12.13	9
	15	8.625	2.000	0.938	398	307	33	3.42	10.25	23	13.38	9
6	3	1.625	0.750	0.031	313	9272	36	0.68	3.25	23	6.25	8
	5	2.750	1.250	0.125	188	1950	22	0.90	4.38	23	7.38	8
	7	3.875	1.563	0.250	207	1080	24	1.30	5.50	23	8.50	8
	9	5.000	1.750	0.375	236	739	27	1.77	6.63	24	9.63	9
	11	6.125	1.875	0.500	271	566	31	2.32	7.75	24	10.75	9
	13	7.250	2.000	0.625	312	465	36	2.93	8.88	25	11.88	10
	15	8.625	2.063	0.813	431	459	50	4.30	10.25	26	13.25	11
8	3	1.875	0.813	0.031	440	16231	83	1.21	4.00	46	6.50	12
	5	3.125	1.375	0.125	264	3506	50	1.58	5.25	47	7.75	13
	7	4.375	1.688	0.250	188	1278	36	1.95	6.50	48	9.00	13
	9	5.750	2.063	0.375	280	1103	53	3.04	7.88	50	10.38	14
	11	7.000	2.250	0.563	310	826	59	3.92	9.13	51	11.63	15
	13	8.500	2.250	0.688	450	817	86	5.72	10.63	53	13.13	17
	15	9.750	2.500	0.875	413	568	79	6.33	11.88	54	14.38	17
10	3	2.125	0.938	0.031	510	22585	149	1.85	4.25	60	7.25	19
	5	3.500	1.563	0.125	306	4989	89	2.47	5.63	62	8.63	20
	7	5.000	2.188	0.313	219	1750	64	3.09	7.13	63	10.13	20
	9	6.500	2.438	0.438	299	1419	87	4.71	8.63	65	11.63	22
	11	8.000	2.500	0.563	431	1357	127	6.99	10.13	66	13.13	24
	13	9.500	2.688	0.688	376	840	111	7.94	11.63	68	14.63	25
	15	11.125	2.875	0.875	533	868	157	10.84	13.25	69	16.25	28

Pipe Size (in.)	No. of Conv. (#)	Live Length (in.)	Axial Movement (in.)	Lateral Movement (in.)	Axial Spring Rate (lbs/in.)	Lateral Spring Rate (lbs/in.)	Angular Spring Rate (lbs-in/deg)	Bellows Weight (lbs)	150# Fixed or Floating Plate Flanges		Weld Nipples	
									OAL (in.)	Weight (lbs)	OAL (in.)	Weight (lbs)
12	3	2.375	1.000	0.031	646	31885	262	2.60	4.50	86	6.25	20
	5	4.000	1.688	0.125	388	6750	157	3.50	6.13	88	7.88	21
	7	5.500	2.313	0.313	277	2547	112	4.41	7.63	90	9.38	22
	9	7.125	2.688	0.438	306	1673	124	5.84	9.25	91	11.00	23
	11	8.875	2.813	0.563	422	1498	172	8.79	11.00	93	12.75	26
	13	10.625	2.875	0.688	593	1471	242	12.16	12.75	95	14.50	29
	15	12.250	3.313	0.938	514	959	210	13.17	14.38	96	16.13	30
14	3	2.375	1.000	0.031	700	41161	339	2.85	4.50	98	8.38	30
	5	4.000	1.688	0.125	420	8712	203	3.85	6.13	100	10.00	31
	7	5.500	2.313	0.250	300	3288	145	4.84	7.63	102	11.50	32
	9	7.125	2.688	0.375	316	2066	153	6.48	9.25	103	13.13	34
	11	8.875	2.813	0.500	459	1942	223	9.64	11.00	105	14.88	37
	13	10.625	2.875	0.625	638	1887	311	13.40	12.75	107	16.63	41
	15	12.250	3.313	0.875	553	1230	269	15.11	14.38	108	18.25	42
16	3	2.375	0.938	0.031	785	59438	489	3.26	4.50	125	8.38	35
	5	4.000	1.625	0.125	471	12577	293	4.40	6.13	126	10.00	36
	7	5.500	2.250	0.188	336	4749	209	5.53	7.63	128	11.50	37
	9	7.125	2.625	0.375	355	2987	221	7.41	9.25	129	13.13	39
	11	8.875	2.813	0.500	497	2707	311	11.14	11.00	133	14.88	42
	13	10.500	3.063	0.625	420	1636	263	12.77	12.63	135	16.50	44
	15	12.250	3.125	0.750	688	1961	429	16.88	14.38	139	18.25	48
18	3	2.625	1.063	0.031	841	66004	663	4.35	4.88	134	8.63	40
	5	4.375	1.813	0.125	504	14257	398	5.95	6.63	136	10.38	41
	7	6.125	2.563	0.250	360	5196	284	7.55	8.38	138	12.13	43
	9	8.000	2.750	0.375	531	4345	406	11.55	10.25	142	14.00	47
	11	9.750	3.375	0.563	420	2394	332	13.85	12.00	144	15.75	49
	13	11.625	3.500	0.688	587	2358	465	18.90	13.88	149	17.63	54
	15	13.500	3.875	0.875	554	1645	437	20.90	15.75	151	19.50	56
20	3	2.625	1.063	0.031	921	88401	888	4.83	5.00	167	8.63	44
	5	4.375	1.813	0.125	553	19095	533	6.61	6.75	169	10.38	46
	7	6.125	2.563	0.250	383	6752	369	8.45	8.50	170	12.13	48
	9	8.000	2.750	0.313	559	5782	540	12.88	10.38	175	14.00	52
	11	9.750	3.375	0.500	457	3186	442	15.14	12.13	177	15.75	54
	13	11.625	3.438	0.625	649	3182	627	21.00	14.00	183	17.63	60
	15	13.500	4.000	0.813	562	2043	543	23.73	15.88	186	19.50	63
24	3	2.625	1.063	0.031	1088	147905	1486	5.79	5.25	230	8.63	53
	5	4.375	1.750	0.063	653	31948	892	7.93	7.00	232	10.38	55
	7	6.125	2.500	0.188	466	11643	637	10.07	8.75	234	12.13	57
	9	7.875	3.063	0.313	363	5478	495	12.21	10.50	236	13.88	60
	11	9.750	3.375	0.438	535	5289	733	18.23	12.38	242	15.75	66
	13	11.500	3.938	0.563	453	3217	621	20.96	14.13	245	17.50	68
	15	13.500	4.000	0.688	659	3397	903	28.58	16.13	253	19.50	76
28	3	3.125	1.125	0.031	1605	209477	2983	10.46	5.88	306	9.13	66
	5	5.250	1.938	0.063	962	44493	1788	14.08	8.00	310	11.25	70
	7	7.250	2.688	0.188	688	16690	1279	17.70	10.00	314	13.25	74
	9	9.375	3.500	0.375	535	7758	994	21.33	12.13	317	15.38	77
	13	11.625	3.813	0.500	702	6634	1307	30.40	14.38	326	17.63	86
30	3	3.125	1.125	0.031	1712	255144	3634	11.21	6.00	349	9.13	71
	5	5.250	1.938	0.063	1026	54191	2178	15.09	8.13	353	11.25	75
	7	7.250	2.688	0.188	734	20329	1558	18.97	10.13	357	13.25	79
	9	9.375	3.500	0.313	571	9450	1211	22.85	12.25	361	15.38	83
	11	11.625	3.813	0.438	749	8083	1593	32.57	14.50	371	17.63	93
	13	13.750	4.500	0.625	634	4888	1348	37.31	16.63	375	19.75	97

CHARTS PRESENTED AS A RESOURCE TO PROVIDE BASELINE DATA FOR DISCUSSION DURING THE INITIAL DESIGN PHASE. For practical purposes, a multitude of expansion joint bellows iterations may meet required operating parameters. Contact Hose Master for assistance in design or selection of the expansion joint best suited for your specific application. • Angular movement for all designs is 5 degrees. • EJMA cycle life 3,000 non-concurrent.

150 PSI

Specifications for 800° F. Pre-Engineered Expansion Joint Products

Pipe Size (in.)	No. of Conv. (#)	Live Length (in.)	Axial Movement (in.)	Lateral Movement (in.)	Axial Spring Rate (lbs/in.)	Lateral Spring Rate (lbs/in.)	Angular Spring Rate (lbs-in/deg)	Bellows Weight (lbs)	150# Fixed or Floating RFISO Flanges		Weld Nipples	
									OAL (in.)	Weight (lbs)	OAL (in.)	Weight (lbs)
2	3	1.000	0.188	0.029	719	7394	11	0.2	3.13	11	4.00	1
	5	1.750	0.375	0.063	440	1476	7	0.2	3.88	11	4.75	1
	6	2.000	0.313	0.063	995	2592	15	0.3	4.13	11	5.00	1
	7	2.500	0.500	0.125	317	522	5	0.2	4.63	11	5.50	1
	9	3.125	0.563	0.188	370	390	6	0.3	5.25	11	6.13	1
	11	4.000	0.625	0.313	432	278	6	0.4	6.13	11	7.00	1
	13	4.625	0.688	0.375	522	245	8	0.6	6.75	11	7.63	1
	15	5.500	0.750	0.500	587	201	9	0.7	7.63	11	8.50	2
2.5	3	1.125	0.250	0.031	787	10287	19	0.3	3.50	16	4.13	3
	5	2.000	0.313	0.063	1078	4421	26	0.4	4.38	16	5.00	3
	7	2.750	0.625	0.125	341	747	8	0.4	5.13	16	5.75	3
	9	3.625	0.688	0.250	414	518	10	0.5	6.00	17	6.63	3
	11	4.625	0.750	0.313	490	420	12	0.7	7.00	17	7.63	3
	13	5.250	0.813	0.375	566	337	14	0.9	7.63	17	8.25	3
	15	6.500	1.063	0.688	813	316	19	1.7	8.88	18	9.50	4
	3	3	1.375	0.313	0.031	1001	12307	34	0.4	3.88	18	4.63
4		1.750	0.438	0.031	818	6334	28	0.6	4.25	19	5.00	4
5		2.250	0.500	0.063	599	2749	20	0.6	4.75	19	5.50	4
7		3.125	0.750	0.188	427	1017	14	0.7	5.63	19	6.38	4
9		4.000	0.813	0.250	451	655	15	0.9	6.50	19	7.25	5
10		4.625	0.913	0.080	436	497	15	1.0	7.13	19	7.88	5
11		5.250	1.250	0.500	607	512	21	1.9	7.75	20	8.50	6
13		6.250	1.313	0.688	718	426	24	2.4	8.75	20	9.50	6
15	7.500	1.500	0.938	839	343	28	2.6	10.00	21	10.75	6	
4	3	1.500	0.313	0.031	1239	19694	65	0.6	4.25	26	4.63	6
	5	2.375	0.500	0.063	743	4709	39	0.7	5.13	26	5.50	6
	6	2.875	0.625	0.063	757	3301	40	0.9	5.63	26	6.00	6
	7	3.375	0.750	0.125	531	1667	28	0.9	6.13	26	6.50	6
	9	4.625	0.938	0.250	498	937	26	1.3	7.38	26	7.75	7
	11	5.625	1.250	0.500	710	804	37	2.5	8.38	28	8.75	8
	13	6.750	1.375	0.625	844	663	44	3.2	9.50	28	9.88	9
	15	8.250	1.500	0.875	913	480	48	4.7	11.00	30	11.38	10
5	3	1.750	0.313	0.031	2225	41387	185	1.1	4.75	31	6.50	8
	5	2.750	0.688	0.063	713	5362	59	1.2	5.75	31	7.50	9
	7	4.000	0.813	0.125	953	3393	79	1.8	7.00	32	8.75	9
	8	4.375	1.000	0.188	740	1987	62	2.3	7.38	32	9.13	10
	9	5.125	1.063	0.250	741	1608	62	2.2	8.13	32	9.88	10
	11	6.875	1.375	0.500	1348	1624	112	5.1	9.88	35	11.63	13
	13	8.125	1.625	0.688	1140	984	95	5.9	11.13	36	12.88	13
	15	10.000	2.000	1.000	1466	841	123	10.1	13.00	40	14.75	17
6	3	1.750	0.313	0.028	2603	66529	297	1.4	5.00	39	6.38	9
	5	2.875	0.563	0.063	1562	14790	178	1.9	6.13	40	7.50	9
	7	4.000	0.813	0.125	1100	5389	126	2.3	7.25	40	8.63	10
	8	4.375	0.938	0.188	877	3231	101	2.6	7.63	41	9.00	10
	9	5.125	1.000	0.188	868	2586	99	2.8	8.38	41	9.75	10
	11	6.250	1.250	0.313	710	1423	81	3.2	9.50	41	10.88	11
	13	8.125	1.625	0.625	1207	1440	139	7.4	11.38	45	12.75	15
	15	9.375	1.875	0.813	1069	957	123	8.1	12.63	46	14.00	16
8	3	2.000	0.375	0.031	2356	76479	446	2.2	5.63	62	6.63	13
	5	3.250	0.688	0.063	1414	17379	268	2.8	6.88	63	7.88	14
	6	3.875	0.813	0.063	1192	9316	204	3.5	7.50	63	8.50	15
	7	4.625	1.000	0.125	1010	6129	191	3.5	8.25	63	9.25	15
	9	5.875	1.250	0.250	786	2955	149	4.1	9.50	64	10.50	15
	11	7.750	1.750	0.438	1311	2845	249	9.7	11.38	70	12.38	21
	13	9.125	2.063	0.625	1110	1737	211	11.1	12.75	71	13.75	22
	15	10.875	2.125	0.813	1464	1626	280	15.3	14.50	75	15.50	27

Pipe Size (in.)	No. of Conv. (#)	Live Length (in.)	Axial Movement (in.)	Lateral Movement (in.)	Axial Spring Rate (lbs/in.)	Lateral Spring Rate (lbs/in.)	Angular Spring Rate (lbs-in/deg)	Bellows Weight (lbs)	150# Fixed or Floating RFSO Flanges		Weld Nipples	
									OAL (in.)	Weight (lbs)	OAL (in.)	Weight (lbs)
10	3	2.250	0.438	0.031	3089	122185	902	3.50	6.25	89	7.38	24
	5	3.750	0.750	0.063	1853	26392	541	4.60	7.75	91	8.88	25
	6	4.375	0.938	0.063	1303	13390	374	4.10	8.38	90	9.50	24
	7	5.125	1.063	0.125	1327	10119	388	5.80	9.13	92	10.25	26
	8	5.875	1.063	0.180	1625	9269	467	6.60	9.88	93	11.00	27
	9	6.625	1.438	0.250	1032	4707	301	7.00	10.63	93	11.75	27
	11	8.625	2.250	0.563	1052	2835	308	13.50	12.63	100	13.75	34
	13	10.375	2.438	0.688	1321	2480	389	19.20	14.38	105	15.50	39
15	12.000	2.563	0.875	1363	1896	398	20.70	16.00	107	17.13	41	
12	3	2.500	0.563	0.031	2853	127109	1159	4.30	7.00	132	6.38	31
	5	4.125	0.875	0.063	2079	34026	844	6.20	8.63	134	8.00	33
	7	5.875	1.250	0.125	1332	11166	538	8.10	10.38	136	9.75	35
	9	7.375	1.688	0.250	952	4876	387	8.80	11.88	137	11.25	36
	11	9.500	1.875	0.438	1002	3088	406	17.10	14.00	145	13.38	44
	13	11.750	2.750	0.750	1366	2752	554	29.20	16.25	157	15.63	56
15	14.125	3.000	0.875	2079	2899	843	39.30	18.63	167	18.00	66	
14	3	2.500	0.563	0.031	3115	165410	1508	4.70	7.13	185	8.50	32
	5	4.125	0.875	0.063	1871	36497	906	6.40	8.75	186	10.13	34
	7	5.750	1.250	0.125	1337	13423	647	8.10	10.38	188	11.75	35
	9	7.375	1.625	0.250	1040	6348	504	9.70	12.00	190	13.38	37
	11	9.500	2.625	0.500	1069	3932	518	18.80	14.13	199	15.50	46
	13	11.375	2.813	0.688	1305	3375	637	27.00	16.00	207	17.38	54
	15	14.125	3.000	0.938	2227	3704	1078	43.30	18.75	223	20.13	71
16	3	2.500	0.813	0.031	4838	332604	3032	6.5	7.63	202	8.50	38
	5	4.125	0.875	0.063	2907	73394	1821	8.80	9.25	205	10.13	40
	7	6.000	1.625	0.188	1892	22449	1179	15.30	11.13	211	12.00	47
	9	7.750	2.000	0.313	1471	10464	917	18.40	12.88	214	13.75	50
	11	9.500	2.500	0.438	1204	5697	750	21.50	14.63	218	15.50	53
	13	11.375	2.563	0.563	1727	5707	1077	29.70	16.50	226	17.38	61
15	13.125	2.875	0.750	1497	3715	933	33.50	18.25	229	19.13	65	
18	3	2.875	0.875	0.031	3444	225434	2717	10.80	8.38	271	8.88	46
	5	4.750	1.438	0.063	2066	49555	1631	14.80	10.25	275	10.75	50
	7	6.625	2.000	0.188	1476	18196	1165	18.80	12.13	279	12.63	54
	9	8.500	2.625	0.375	1148	8598	906	22.70	14.00	283	14.50	58
	11	10.500	2.688	0.500	1630	7998	1286	32.00	16.00	292	16.50	67
	13	12.500	3.125	0.688	1378	4771	1087	36.70	18.00	297	18.50	72
	15	14.625	3.375	0.750	1583	4035	1259	50.70	20.13	311	20.63	86
20	3	2.875	0.813	0.031	3779	302231	3643	12.00	8.75	342	8.88	51
	5	4.750	1.438	0.063	2268	66445	2168	16.40	10.63	346	10.75	56
	7	6.625	2.000	0.188	1620	24400	1562	20.90	12.50	351	12.63	60
	9	8.500	2.563	0.313	1260	11529	1215	25.30	14.38	355	14.50	65
	11	10.500	2.688	0.438	1799	10790	1735	35.50	16.38	366	16.50	75
	13	12.500	3.188	0.625	1521	6436	1466	40.80	18.38	371	18.50	80
	15	14.625	3.313	0.750	1924	5965	1861	55.00	20.50	385	20.63	94
24	3	2.875	0.563	0.022	4475	507266	6115	14.40	9.50	454	8.88	62
	5	4.750	0.938	0.063	2688	111629	3673	19.70	11.38	460	10.75	67
	7	6.625	1.375	0.125	1921	41009	2625	25.00	13.25	465	12.63	72
	9	8.500	2.313	0.250	2328	29419	3192	37.30	15.25	477	14.63	85
	11	10.500	2.875	0.375	1813	15483	2489	44.30	17.13	484	16.50	92
	13	12.500	3.188	0.500	1533	9235	2104	51.00	19.13	491	18.50	98
15	14.625	3.438	0.625	2080	9164	2859	67.50	21.25	508	20.63	115	
28	3	3.375	0.750	0.030	5743	643069	10682	25.10	10.50	563	9.38	81
	5	5.625	1.250	0.063	3446	138903	6409	33.80	12.75	572	11.63	90
	7	7.750	1.938	0.125	2467	52380	4588	42.40	14.88	580	13.75	98
	9	10.000	2.438	0.250	1918	24458	3567	51.10	17.13	589	16.00	107
	11	12.500	3.313	0.438	2177	17846	4067	71.90	19.63	610	18.50	128
13	14.750	3.750	0.625	1843	10847	3442	82.40	21.88	620	20.75	138	
30	3	3.375	1.125	0.031	5732	732456	12167	33.40	10.63	639	9.38	93
	5	5.750	1.938	0.063	3429	150958	7279	44.90	13.00	651	11.75	105
	7	8.000	2.688	0.188	2451	55751	5203	56.90	15.25	663	14.00	117
	9	10.250	3.438	0.375	1908	26427	4049	67.90	17.50	674	16.25	128
	11	12.875	3.563	0.438	2742	24078	5821	94.90	20.13	701	18.88	155
13	15.500	4.438	0.688	1797	10900	3819	121.50	22.75	728	21.50	182	

CHARTS PRESENTED AS A RESOURCE TO PROVIDE BASELINE DATA FOR DISCUSSION DURING THE INITIAL DESIGN PHASE. For practical purposes, a multitude of expansion joint bellows iterations may meet required operating parameters. Contact Hose Master for assistance in design or selection of the expansion joint best suited for your specific application. • Angular movement for all designs is 5 degrees. • EJMA cycle life 3,000 non-concurrent.

300 PSI

Specifications for 800° F. Pre-Engineered Expansion Joint Products

Pipe Size (in.)	No. of Conv. (#)	Live Length (in.)	Axial Movement (in.)	Lateral Movement (in.)	Axial Spring Rate (lbs/in.)	Lateral Spring Rate (lbs/in.)	Angular Spring Rate (lbs-in/deg)	Bellows Weight (lbs)	150# Fixed RFSO Flanges		Weld Nipples		300# Lap Joint Flanges	
									OAL (in.)	Weight (lbs)	OAL (in.)	Weight (lbs)	OAL (in.)	Weight (lbs.)
2	3	1.125	0.250	0.031	987	8070	15	0.19	3.88	14	4.13	1	6.13	19
	5	1.875	0.438	0.063	592	1743	9	0.34	4.63	14	4.88	1	6.88	19
	7	2.625	0.563	0.188	676	1014	10	0.49	5.38	14	5.63	1	7.63	19
	9	3.500	0.625	0.250	818	691	12	0.66	6.25	15	6.50	2	8.50	19
	11	4.250	0.690	0.313	930	535	14	0.87	7.00	15	7.25	2	9.25	19
	13	5.500	0.813	0.563	1314	455	20	1.49	8.25	15	8.50	2	10.50	20
	15	6.500	0.875	0.688	1627	403	25	1.86	9.25	16	9.50	3	11.50	20
2.5	3	1.250	0.250	0.031	1299	13638	31	0.43	4.38	20	4.25	2	6.25	27
	5	2.000	0.438	0.063	760	3116	18	0.55	5.13	21	5.00	2	7.00	27
	7	3.000	0.625	0.188	861	1569	21	0.78	6.13	21	6.00	2	8.00	28
	9	3.875	0.750	0.250	874	963	21	1.08	7.00	21	6.88	3	8.88	28
	11	5.000	0.875	0.438	1289	851	31	1.84	8.13	22	8.00	3	10.00	29
	13	6.125	0.938	0.563	1569	690	38	2.33	9.25	22	9.13	4	11.13	29
	15	7.250	1.063	0.750	1556	496	38	3.01	10.38	23	10.25	4	12.25	30
3	3	1.375	0.313	0.031	1570	19301	53	0.75	4.88	27	4.63	3	6.38	36
	5	2.375	0.563	0.063	953	3928	32	0.99	5.88	27	5.63	3	7.38	36
	7	3.375	0.750	0.188	958	1956	32	1.38	6.88	27	6.63	3	8.38	37
	9	4.375	0.875	0.313	1012	1229	34	1.83	7.88	28	7.63	4	9.38	37
	11	5.500	1.000	0.438	1241	978	43	2.83	9.01	29	8.75	5	10.50	38
4	3	1.500	0.313	0.031	1932	30705	101	0.97	5.38	45	4.63	4	6.97	59
	5	2.500	0.563	0.063	1159	6632	60	1.28	6.38	45	5.63	4	7.28	59
	7	3.500	0.813	0.188	828	2417	43	1.59	7.38	46	6.63	4	7.59	59
	9	4.750	0.875	0.250	1215	1927	63	2.38	8.63	46	7.88	5	8.38	60
	11	6.250	1.125	0.438	1639	1505	86	4.14	10.13	48	9.38	7	10.14	62
5	3	1.750	0.375	0.031	2540	47232	211	1.70	5.88	58	6.50	7	7.75	81
	5	3.000	0.688	0.063	1522	9632	126	2.30	7.13	58	7.75	8	9.00	82
	7	4.250	1.000	0.188	1088	3429	90	2.90	8.38	59	9.00	9	10.25	83
	9	5.625	1.063	0.313	1647	2965	137	4.36	9.75	60	10.38	10	11.63	84
	11	7.375	1.250	0.438	1614	1731	137	8.22	11.50	64	12.13	14	13.38	88
6	3	1.750	0.375	0.031	2958	75609	338	2.26	6.00	80	6.38	9	8.75	111
	5	3.000	0.688	0.063	1773	15420	202	2.97	7.25	81	7.63	10	10.00	111
	7	4.250	0.938	0.188	1265	5481	144	3.69	8.50	82	8.88	11	11.25	112
	9	5.625	1.063	0.250	1743	4339	200	5.61	9.88	84	10.25	13	12.63	114
	11	6.875	1.250	0.375	1426	2377	164	6.52	11.13	85	11.50	13	13.88	115
8	3	1.750	0.375	0.031	2958	75609	338	2.26	6.00	80	6.38	9	8.75	111
	5	3.000	0.688	0.063	1773	15420	202	2.97	7.25	81	7.63	10	10.00	111
	7	4.250	0.938	0.188	1265	5481	144	3.69	8.50	82	8.88	11	11.25	112
	9	5.625	1.063	0.250	1743	4339	200	5.61	9.88	84	10.25	13	12.63	114
	11	6.875	1.250	0.375	1426	2377	164	6.52	11.13	85	11.50	13	13.88	115
10	3	2.125	0.375	0.031	5178	148862	980	4.30	7.13	120	6.75	15	10.13	168
	5	3.500	0.688	0.063	3111	32971	589	5.61	8.50	122	8.13	17	11.50	169
	7	4.875	1.000	0.125	2223	12146	421	6.92	9.88	123	9.50	18	12.88	171
	9	6.375	1.250	0.250	1726	5513	327	8.24	11.38	124	11.00	19	14.38	172
	11	8.000	1.375	0.375	2289	4662	435	11.62	13.00	128	12.63	23	16.00	175
	13	9.375	1.625	0.500	1938	2875	368	13.23	14.38	129	14.00	24	17.38	177
	15	11.750	1.813	0.750	3038	2857	575	21.65	16.75	138	16.38	33	19.75	185
10	3	2.375	0.563	0.031	4038	143160	1178	5.76	7.75	168	7.50	23	12.38	267
	5	4.125	1.000	0.063	3758	44262	1098	11.55	9.50	174	9.25	29	14.13	273
	7	5.750	1.375	0.188	2686	16281	785	14.43	11.13	176	10.88	32	15.75	275
	9	7.500	1.813	0.375	2084	7427	609	17.30	12.88	179	12.63	35	17.50	278
	11	9.625	2.188	0.563	2565	5536	748	26.45	15.00	188	14.75	44	19.63	287
	13	11.125	2.250	0.688	2380	3867	698	28.01	16.50	190	16.25	45	21.13	289
	15	13.750	2.500	0.875	3119	3313	913	41.33	19.13	203	18.88	59	23.75	302

Pipe Size (in.)	No. of Conv. (#)	Live Length (in.)	Axial Movement (in.)	Lateral Movement (in.)	Axial Spring Rate (lbs/in.)	Lateral Spring Rate (lbs/in.)	Angular Spring Rate (lbs-in/deg)	Bellows Weight (lbs)	300# Fixed RFSO Flanges		Weld Nipples		300# Lap Joint Flanges	
									OAL (in.)	Weight (lbs)	OAL (in.)	Weight (lbs)	OAL (in.)	Weight (lbs.)
12	3	2.625	0.563	0.031	6254	252733	2540	8.61	8.50	239	6.50	26	14.63	386
	5	4.375	0.938	0.063	3752	54590	1524	11.59	10.25	242	8.25	29	16.38	389
	7	6.125	1.313	0.188	2680	19894	1088	14.57	12.00	245	10.00	32	18.13	392
	9	7.875	1.688	0.313	2085	9360	847	17.55	13.75	248	11.75	35	19.88	395
	11	10.500	2.375	0.563	2259	5705	917	33.90	16.38	264	14.38	51	22.50	411
14	3	2.625	0.500	0.031	5656	274635	2760	9.72	8.75	340	8.63	37	14.63	516
	5	4.375	0.625	0.063	3961	68771	1920	12.80	10.50	343	10.38	40	16.38	519
	7	6.125	1.250	0.125	2424	21619	1183	16.63	12.25	347	12.13	44	18.13	523
	9	7.875	1.313	0.188	2067	11105	1004	19.67	14.00	350	13.88	47	19.88	526
	11	10.375	2.250	0.500	2764	8556	1343	34.31	16.50	364	16.38	62	22.38	540
16	3	2.750	0.750	0.031	5507	314156	3465	14.01	9.38	394	8.75	45	14.75	661
	5	4.500	1.250	0.063	3305	70409	2079	19.03	11.13	399	10.50	50	16.50	666
	7	6.375	1.750	0.188	2360	25056	1485	24.05	13.00	404	12.38	55	18.38	671
	9	8.125	1.938	0.313	2379	15393	1482	27.42	14.75	407	14.13	59	20.13	674
	11	10.500	2.500	0.500	2784	10787	1734	42.50	17.13	423	16.50	74	22.50	690
18	3	2.875	0.313	0.016	7933	523178	6306	15.58	10.00	656	8.88	51	14.88	804
	5	5.125	1.125	0.063	5690	115951	4441	30.04	12.25	670	11.13	65	17.13	818
	7	7.125	1.625	0.125	4152	44257	3276	33.51	14.25	674	13.13	69	19.13	822
	9	9.125	2.188	0.313	3122	24899	3024	41.01	16.25	681	15.13	76	21.13	829
	11	12.000	3.188	0.563	2839	10669	2240	65.63	19.13	706	18.00	101	24.00	854
20	3	3.000	0.625	0.031	10209	751004	9857	21.67	10.63	652	9.00	61	15.00	978
	5	5.125	0.938	0.063	6103	153845	5893	29.63	12.75	660	11.13	69	17.13	986
	7	7.125	1.250	0.125	4575	59572	4410	37.22	14.75	667	13.13	77	19.13	993
	9	9.125	2.188	0.313	3122	24899	3024	46.43	16.75	676	15.13	86	21.13	1002
	11	11.875	3.125	0.563	3010	14271	2935	75.77	19.50	706	17.88	115	23.88	1032
24	3	3.125	0.500	0.020	18359	1767345	25170	30.60	11.63	981	9.13	78	15.13	1409
	5	5.250	0.875	0.063	10405	355465	14288	42.37	13.75	992	11.25	90	17.25	1420
	7	7.375	1.250	0.125	7327	126889	10065	54.02	15.88	1004	13.38	101	19.38	1432
	9	9.375	2.063	0.250	5146	55323	7091	67.13	17.88	1017	15.38	114	21.38	1445
	11	11.500	2.563	0.375	4208	30065	5798	79.02	20.00	1029	17.50	126	23.50	1457

CHARTS PRESENTED AS A RESOURCE TO PROVIDE BASELINE DATA FOR DISCUSSION DURING THE INITIAL DESIGN PHASE. For practical purposes, a multitude of expansion joint bellows iterations may meet required operating parameters. Contact Hose Master for assistance in design or selection of the expansion joint best suited for your specific application. • Angular movement for all designs is 5 degrees. • EJMA cycle life 3,000 non-concurrent.



Training & Education

Core to Hose Master's success is a commitment to continuing education and shared expertise with our distributors and customers alike.

Hose Master University (HMU) was created to provide a structured curriculum in understanding expansion joints, their industries, and their applications.



Expansion Joint 101 coursework is taught at our Cleveland, Ohio headquarters training center. On-site training offers students the opportunity to interact with Hose Master staff members in a manufacturing environment, giving them first-hand knowledge of raw materials, product design, manufacturing, fabrication, and testing.

Building upon the foundation of HMU, Hose Master offers continuing education opportunities by way of **Application by Industry Webinars**. These webinars offer the next step in developing practical in-field product and application know-how for more than 10 major industries.

Throughout North America, Hose Master sales engineers regularly conduct field inspections and surveys to identify solutions for the most demanding applications and environments. As on-site resources they also provide design assistance, systems recommendations, training, and education.

Industries

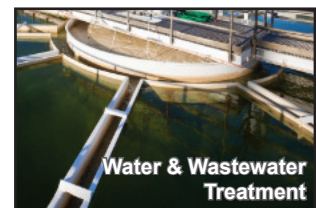

Expansion Joint Specification Inquiry Sheet

For ease in ordering custom designed expansion joints, please complete the chart below and fax it to (216) 481-7557 or email it to insidesales@hosemaster.com

Date: _____

Inquiry Number: _____

Company Name: _____

Contact Name: _____ Contact Number: _____

Design Information <small>* Minimum Required Information</small>	Item #1	Item #2	Item #3
* Quantity			
* Nominal Size / ID (in.) Pipe / Tube (in.)			
* Expansion Joint Type (Single, Universal, etc.)			
* End Fittings Inlet Outlet			
Media			
Velocity (feet per second)			
Installation Position - Vertical or Horizontal			
* Design Pressure (psi)			
* Design Temperature (degree F.)			
Material Bellows / Liner			
Material Inlet Fitting Outlet Fitting			
Material Hardware			
Tie Rods / Limit Rods			
Cover (check to request - If checked, removable or fixed)			
Design Movements			
Axial Compression (in.)			
Axial Extension (in.)			
Lateral (in.)			
Angular (degrees)			
Number of Cycles			
Dimensional Limitations			
Overall Length (in.)			
Overall OD (in.)			
Flow Liner			
Spring Rate (lbs/in.)			
QA Requirements - NDE			
Design Code (EJMA, B31.3, etc.)			
Special Flange Design			
Facing (Machining)			
O.D. (in.)			
I.D. (in.)			
Thickness (in.)			
Bolt Circle Diameter (in.)			
Number of Holes			
Hole Diameter (in.)			



PED
Pressure
Equipment
Directive



ASME IX
Certified Welders



HOSE MASTER

1233 East 222nd Street • Cleveland, Ohio 44117
(800) 221-2319 • Fax: (216) 481-7557 • www.hosemaster.com
Cleveland • Houston • Atlanta

ISO 9001
Registered Quality System



